



TODO EN 1

- + Máquina autónoma
Concepto **stand-alone**
- + Plug & Play

FÁCIL USO

- + Ficheros de marcaje:
Programación fácil
mediante PC
- + Inicio rápido

SISTEMA COMPACTO

- + Electrónica integrada
- + Ahorro de espacio en
armarios eléctricos

The first machine that
integrates its controller!



E-SMART CABEZAL DE MARCAJE. ESPECIFICACIONES

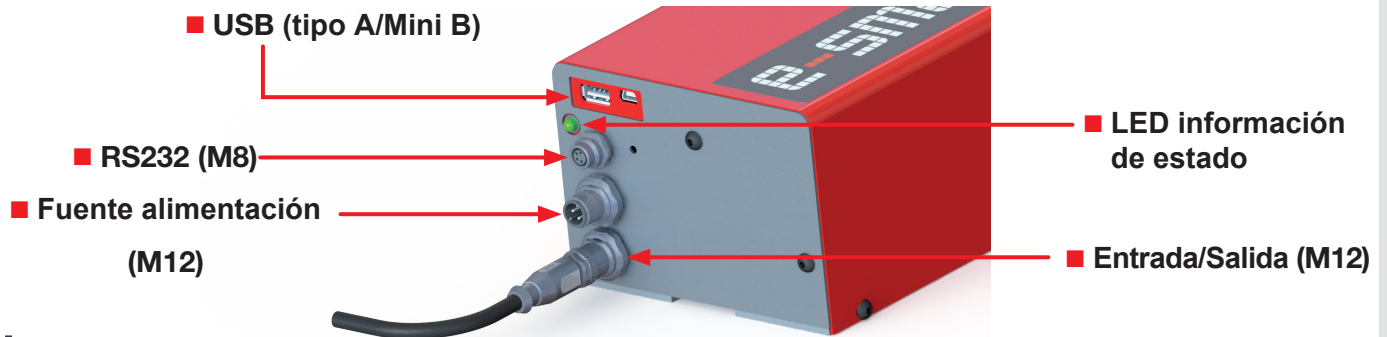

+ Todos los cables suministrados

EJEMPLOS DE MARCAJE

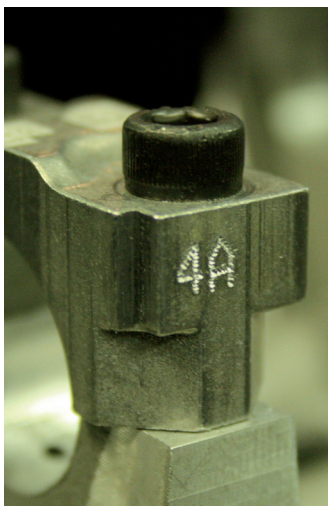

CARACTERÍSTICAS TÉCNICAS

e-smart

Área de marcado	50 x 20 mm
Dimensiones exterior	312 x 122 x 88 mm
Peso	3,5 kg
Longitud del cable	5m (10m opcional)
Protección	Fuelle de cuero
Entradas / Salidas	7E / 3S
Puertos de comunicación	USB / RS232

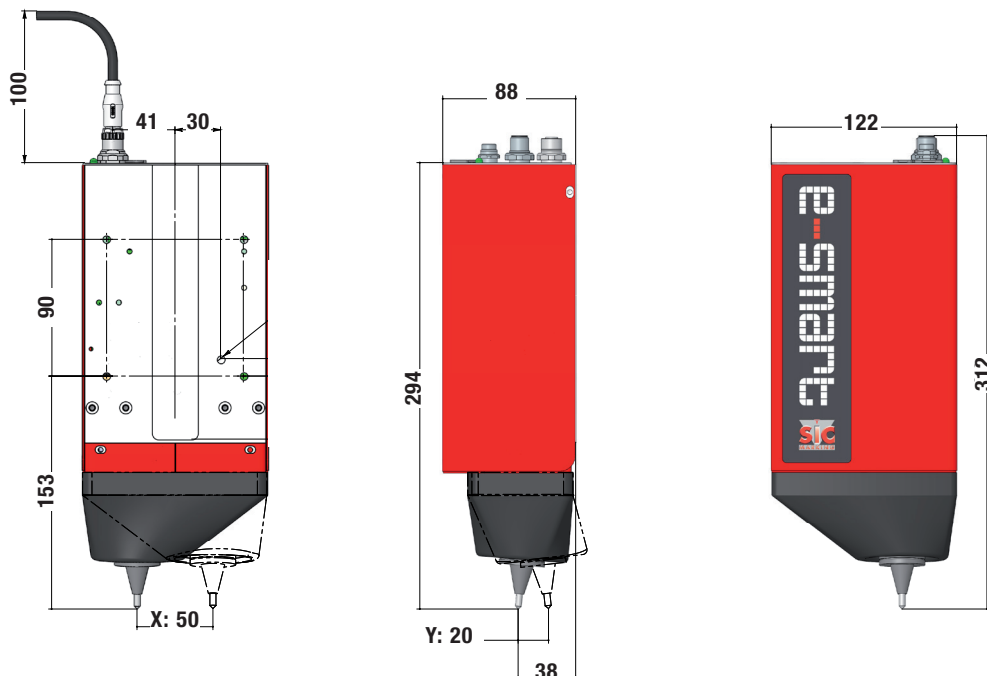

Área de marcado-50 x 20 mm

PROGRAMMING ON PC

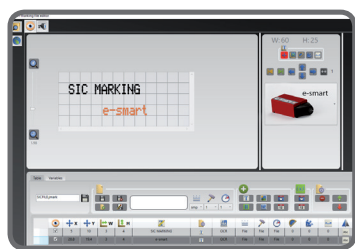

■ Programa intuitivo para PC

■ Puerto USB cargar ficheros y comunicación con PC

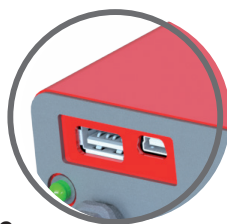

■ Botón Inicio/Paro
Caja con selector de 4 archivos (opcional)

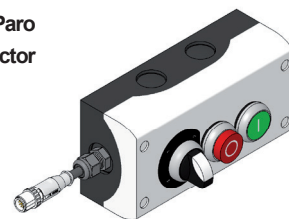

APLICACIONES

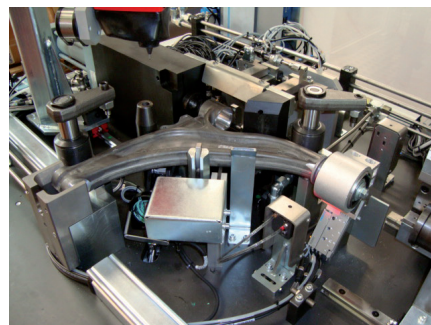
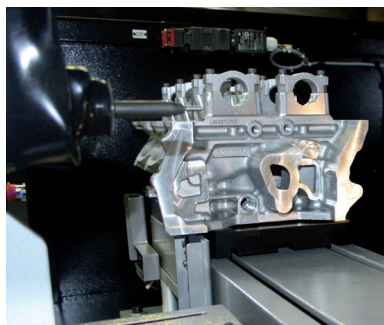
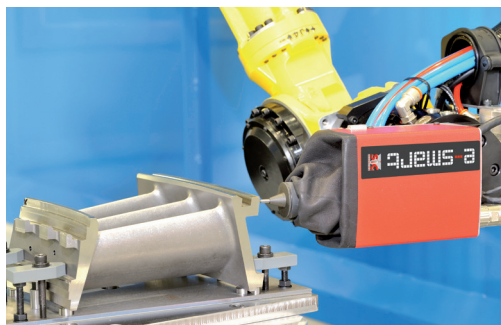

SIVART, S.L.

Av. Pau Casals, 29 Local-1
08392 Sant Andreu Llavanes
Barcelona
Telf.: +34 93 793 02 55
www.sivartsl.com
info@sivartsl.com

